

XMG-51

DMX Merger User Manual



XMG-51 DMX Merger
User Manual
Issue 1.01 (2017-08-30)

Copyright © 2017 SWISSON AG

No part of this documentation may be reproduced or transmitted in any form or by any means, electronic or mechanical, including photocopying and recording, without the prior written permission of SWISSON AG.

The information in this documentation is supplied without warranty of any kind, either directly or indirectly, and is subject to change without prior written notice. Swisson, its employees or appointed representatives will not be held responsible for any damages to software, hardware, or data, arising as a direct or indirect result of the product(s) mentioned herein.

Issued by

SWISSON AG
Fabrikstrasse 21
CH-3250 Lyss
Switzerland

E-Mail: welcome@swisson.com

Table of contents

Overview.....	4
Bypass.....	7
Manual switching.....	7
The main menu.....	8
Keyboard lock / password.....	9
Restore the XMG-51.....	10
Change merge mode.....	10
HTP.....	11
LTP ch.....	11
LTP line.....	13
The Single mode.....	14
Offset.....	16
Overview of the menu.....	18
Technical data.....	19
Safety notes.....	20

Overview

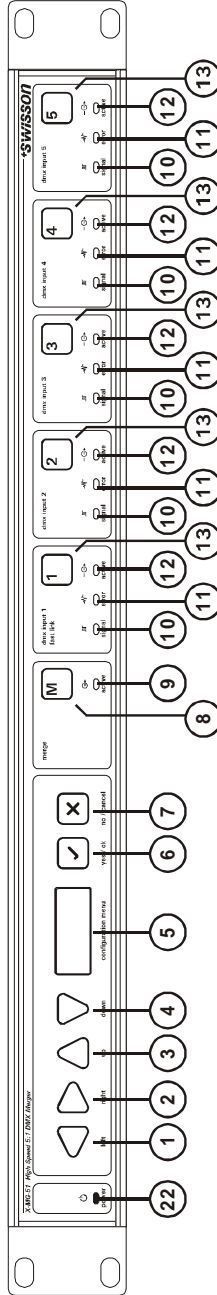
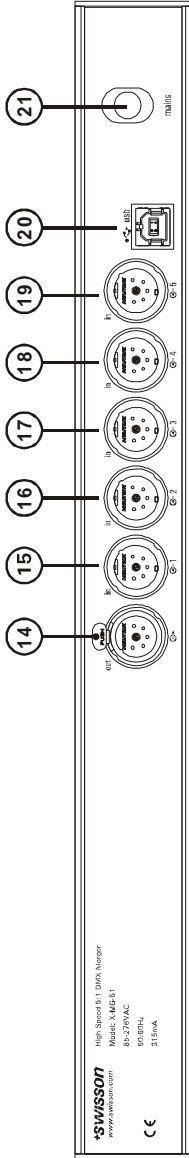



With the XMG-51 you get a powerful DMX merger with numerous options. The merger is suitable for many applications.

This manual familiarizes you with all the functions of the XMG-51 and introduces you to the topic of merging light control data.

1  **LEFT**
With this button, the cursor on the display is moved one position to the left

2  **RIGHT**
With this button, the cursor on the display is moved one position to the right

3  **UP**
This button is for scrolling up in the menu or to increase a number

4  **DOWN**
This button is for scrolling down in the menu or to decrease a number

5 **DISPLAY**
LCD display with LED backlight

6  **YES/OK**
Pressing this button will confirm any entered value or choose a selected menu item

7  **NO/CANCEL**
Pressing this button will cancel any entered value or exit from the currently active menu

8  **MERGE**
Pressing this button will activate the merger

9  **MERGE ACTIVE**
This LED shows if the merger is active

10



SIGNAL

This LED shows if there is a signal on the corresponding input

11



ERROR

The error LED will glow red if there are any errors in the DMX data of the corresponding input

12



ACTIVE

When there is a value that is currently being propagated through to the output from the corresponding input, this LED will light up

13



INPUT

Pressing one of these buttons will switch the corresponding input directly to the output

14

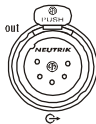

DMX OUTPUT

XLR socket for the DMX output signal

15

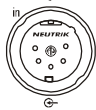

DMX INPUT 1

DMX input line 1

16

DMX INPUT 2

DMX input line 2

17

DMX INPUT 3

DMX input line 3

18

DMX INPUT 4

DMX input line 4

19

DMX INPUT 5

DMX input line 5

20



USB SOCKET

This USB link is for downloading software updates

21

POWER INPUT

Power input

85-275 VAC

22



POWER ON

As soon as the internal power supply is stable, this LED will light up

Bypass

If the XMG-51 is powered down, DMX input line1 is switched directly to the output:

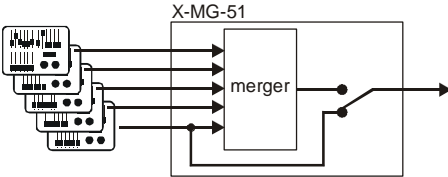

Manual switching

- With the button the merger is activated:

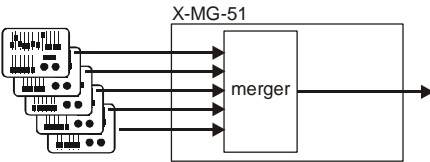

- When one of the buttons - is pressed, the corresponding input line is directly switched to the output. In this state, the merger is deactivated:

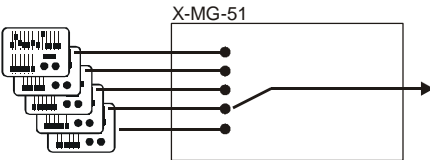

The main menu

About two seconds after powering up the merger, the following information will appear on the display:



If the menu is locked by a password (see section keyboard lock / password) the following information will appear on the display if any menu button is pressed:



The password can be entered with the menu buttons and confirmed with the OK button. If the password is wrong, the value on the display will be set back to 0000. If the correct password was entered, the XMG-51 will go to the main menu. The main menu contains the following 4 options:



The UP and DOWN buttons are used to navigate through the menu. The following text --MENU-- will always appear on the top line of the display when in the menu mode.

Keyboard lock / password

To activate the keyboard lock or to change the password, choose LOCK in the main menu and press OK. You are now in the password menu. There are 3 options to choose from:

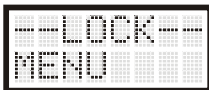

MENU - If you choose this option, the menu will be locked but the switch buttons can still be used.

Press OK to enter a new password.

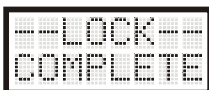

COMPLETE - In this option, the whole keyboard of the merger will be locked; the XMG-51 can't be manipulated by anyone other than the person who knows the password. Press OK to enter a new password.

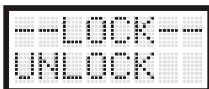

UNLOCK - This option unlocks the whole merger. The menu and the switch buttons are unlocked and can be manipulated by anyone.

Restore the XMG-51

The XMG-51 has many adjustable parameters. In some cases, it may be practical to set back all parameters to their default settings.

Select RESTORE in the main menu and press OK. Once that is done, the XMG-51 will display the following:



If the OK button is pressed again, all parameters will be set back to their original default settings:

- Merge mode of all channels is HTP
- All offsets are set to 1

Change merge mode

To change the merge mode, go to MERGE in the main menu and press OK. There are now 4 options to choose from:



The following chapters will give you a brief overview about these modes.

HTP

HTP (Higher Takes Precedence) means that the highest value of all inputs always takes precedence. The following picture will explain this in more detail. You can see a simplified DMX data stream on every input. The highest value of each channel is marked in green:

DMX In 1	DMX In 2	DMX In 3	DMX In 4	DMX In 5	DMX Out	
0	0	254	255	45	255	Ch 1
10	0	0	100	0	100	Ch 2
90	78	0	46	32	90	Ch 3
200	100	54	0	100	200	Ch 4
48	0	35	41	0	48	Ch 5
0	50	78	0	5	78	Ch 6
135	128	0	10	150	150	Ch 7
18	255	0	0	0	255	Ch 8
<hr/>						
87	36	255	0	0	255	Ch 511
25	0	0	0	0	25	Ch 512

As illustrated above, the highest value of each DMX channel takes precedence over other values of that same channel.

To choose HTP, select MERGE in the main menu, press OK and then select HTP and press OK again.
After two seconds, a confirmation is displayed and all the channels are set to HTP.

LTP ch

LTP ch (Last Takes Precedence - channel) means that for each output channel, the merger selects the corresponding input channel whose value changed most recently. The depiction below shows how this works using an example of four sequential DMX packages. The changed values are marked in yellow.

+SWISSON

DMX In 1	DMX In 2	DMX In 3	DMX In 4	DMX In 5	DMX Out	
0	0	254	255	45	0	Ch 1
10	0	0	100	0	10	Ch 2
90	78	0	46	32	90	Ch 3
200	100	54	0	100	200	Ch 4
48	0	35	41	0	48	Ch 5
0	50	78	0	5	0	Ch 6
135	128	0	10	150	135	Ch 7
18	255	0	0	0	18	Ch 8
<hr/>						
87	36	255	0	0	87	Ch 511
25	0	0	0	0	25	Ch 512

DMX In 1	DMX In 2	DMX In 3	DMX In 4	DMX In 5	DMX Out	
0	0	254	255	45	0	Ch 1
10	0	0	100	0	10	Ch 2
90	78	0	46	32	90	Ch 3
200	110	54	0	100	110	Ch 4
48	0	35	41	0	48	Ch 5
0	50	78	0	5	0	Ch 6
135	128	0	10	150	135	Ch 7
18	255	0	0	0	18	Ch 8
<hr/>						
87	36	255	0	0	87	Ch 511
25	0	0	0	0	25	Ch 512

DMX In 1	DMX In 2	DMX In 3	DMX In 4	DMX In 5	DMX Out	
0	0	254	255	45	0	Ch 1
10	0	0	100	0	10	Ch 2
90	78	0	46	32	90	Ch 3
200	110	54	0	100	110	Ch 4
48	0	35	41	0	48	Ch 5
0	50	100	0	5	100	Ch 6
135	128	0	0	150	0	Ch 7
18	255	0	0	0	18	Ch 8
<hr/>						
87	36	255	0	0	87	Ch 511
25	0	0	0	0	25	Ch 512

DMX In 1	DMX In 2	DMX In 3	DMX In 4	DMX In 5	DMX Out	
0	0	254	255	45	0	Ch 1
10	0	0	100	0	10	Ch 2
90	78	0	46	32	90	Ch 3
199	110	54	0	100	199	Ch 4
48	0	35	41	0	48	Ch 5
0	50	100	0	5	100	Ch 6
135	128	0	0	150	0	Ch 7
18	255	0	0	0	18	Ch 8
<hr/>						
87	36	255	0	0	87	Ch 511
25	0	0	0	0	25	Ch 512

To choose LTP ch, go to MERGE in the main menu, press OK and then select LTP CH and press OK again. After 2 seconds, a

confirmation will appear on the display. At that point all the channels of the XMG-51 will be set to LTP ch.

LTP line

LTP line (Last Takes Precedence line) is very akin to LTP ch. With LTP line, the line (input) on which any value has changed last takes precedence over the other lines.

The following picture will explain this in more detail. You can see 4 sequential DMX packages; the changed values are marked in yellow:

DMX In 1	DMX In 2	DMX In 3	DMX In 4	DMX In 5	DMX Out	
0	0	254	255	45	0	Ch 1
10	0	0	100	0	10	Ch 2
90	78	0	46	32	90	Ch 3
200	100	54	0	100	200	Ch 4
48	0	35	41	0	48	Ch 5
0	50	78	0	5	0	Ch 6
135	128	0	10	150	135	Ch 7
18	255	0	0	0	18	Ch 8
87	36	255	0	0	87	Ch 511
25	0	0	0	0	25	Ch 512

DMX In 1	DMX In 2	DMX In 3	DMX In 4	DMX In 5	DMX Out	
0	0	254	255	45	0	Ch 1
10	0	0	100	0	0	Ch 2
90	78	0	46	32	78	Ch 3
200	110	54	0	100	110	Ch 4
48	0	35	41	0	0	Ch 5
0	50	78	0	5	50	Ch 6
135	128	0	10	150	128	Ch 7
18	255	0	0	0	255	Ch 8
87	36	255	0	0	36	Ch 511
25	0	0	0	0	0	Ch 512



DMX In 1	DMX In 2	DMX In 3	DMX In 4	DMX In 5	DMX Out	
0	0	254	255	45	254	Ch 1
10	0	0	100	0	0	Ch 2
90	78	0	46	32	0	Ch 3
200	110	54	0	100	54	Ch 4
48	0	35	41	0	35	Ch 5
0	50	100	0	5	100	Ch 6
135	128	0	10	150	0	Ch 7
18	255	0	0	0	0	Ch 8
87	36	255	0	0	255	Ch 511
25	0	0	0	0	0	Ch 512

DMX In 1	DMX In 2	DMX In 3	DMX In 4	DMX In 5	DMX Out	
0	0	254	255	45	0	Ch 1
10	0	0	100	0	10	Ch 2
90	78	0	46	32	90	Ch 3
199	110	54	0	100	199	Ch 4
48	0	35	41	0	48	Ch 5
0	50	100	0	5	0	Ch 6
135	128	0	0	150	135	Ch 7
18	255	0	0	0	18	Ch 8
87	36	255	0	0	87	Ch 511
25	0	0	0	0	25	Ch 512

To choose LTP line, go to MERGE in the main menu, press OK and then select LTP LINE and press OK again. After 2 seconds, a confirmation will appear and all channels of the XMG-51 will be set to LTP line.

Single mode

With the XMG-51, it is possible to configure each DMX channel separately to one of the described merge modes. With this feature it is possible to solve almost any DMX merging problem. The following picture shows a possible merge configuration on each DMX channel:

Only HTP	Only LTPch	Only LTPIn	Single Mode	
HTP	LTPch	LTPIn	HTP	Ch 1
HTP	LTPch	LTPIn	LTPch	Ch 2
HTP	LTPch	LTPIn	LTPch	Ch 3
HTP	LTPch	LTPIn	LTPIn	Ch 4
HTP	LTPch	LTPIn	LTPIn	Ch 5
HTP	LTPch	LTPIn	HTP	Ch 6
HTP	LTPch	LTPIn	LTPch	Ch 7
HTP	LTPch	LTPIn	HTP	Ch 8
HTP	LTPch	LTPIn	LTPIn	Ch 511
HTP	LTPch	LTPIn	HTP	Ch 512

This Single mode list can be saved. Once saved, this list can always be recalled.

To enter the Single Mode, go to MERGE in the main menu, press OK and select SINGLE and press OK again. You are now in the Single mode menu where you can select from 3 options:



RECALL - This recalls the saved Single list.



RESET - The Single list will be cleared by choosing this option. The user can choose on which merge mode the Single list will be cleared.



EDIT – This option allows for the Single list to be edited.

If you want to change the Single list, the following information appears on the display:



With the arrow buttons you can choose the DMX channel on which you want to set a certain mode. When you have entered your choice, press OK:

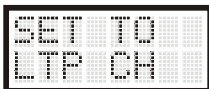
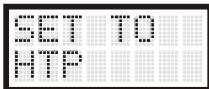

Now you can choose a merge mode for this channel. After choosing the mode by pressing OK, the display will show the channel number, which will be incremented by 1 automatically. Thus, all channels can be set separately to a merge mode. When you are done with editing the Single list, press CANCEL. You will see the following information on the display:



If you now press OK, the just entered Single list will be active and saved.

If you press CANCEL instead, the just entered Single list will be active but not saved.

Offset

On the XMG-51 there is the option to select an offset on each input line but on line 1.

With this feature, the DMX data is shifted up in the DMX stream. See the following illustration for a better understanding:

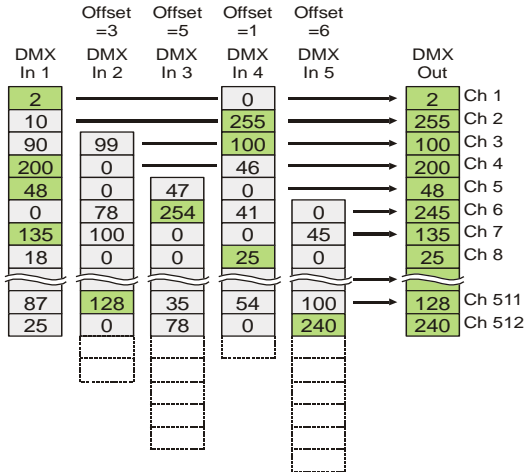

In the above example, the merger is operated in HTP mode. You can see that the DMX values are shifted before they are merged. Because of the shifting, there is surplus DMX data which is cut off and will not have any effect on the process. Input lines 2 to 5 can be configured with an offset between 1 and 512.

The offset number indicates to which DMX channel the first channel of the corresponding input is shifted before being merged.

To set offset, choose OFFSET in the main menu and press OK. You now can choose the input line which you want to configure with an offset:



Once the desired input line is selected, press OK. The following information will appear on the display:



Using the arrow buttons, you can select the offset value. Enter the value and confirm by pressing OK.

Overview of the menu

The following flowchart shows the entire overview of the X-MG-51's menu:

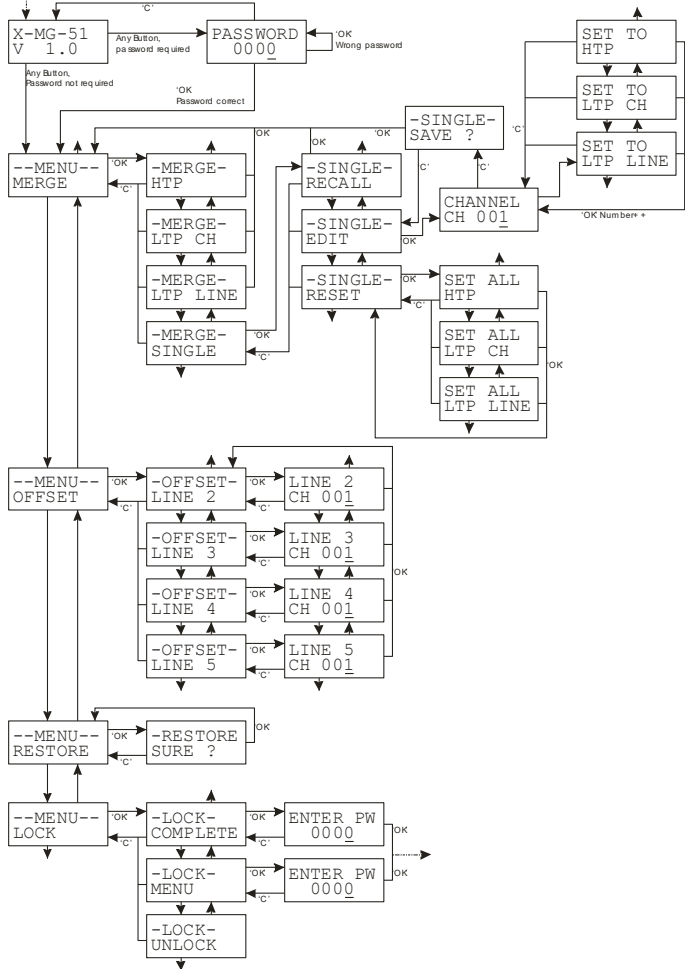

Technical Data

Data Input	5 DMX inputs / individually galvanically isolated from the DMX output 1 USB port for software updates
Data Output	1 DMX output galvanic isolated
DMX Refresh Rate	Constant 40.3 Hz independent from the refresh-rates of the input lines
Break length	180 us
MAB length	16 us
Merge Modus	HTP / LTP ch / LTP line Each channel can be adjusted separately
Offset	Input lines 2 - 5 from 1 to 512
Bypass	Input line1 directly connected to output
Measurements	L=430mm / B=109mm / H=45mm
Weight	1.4 kg
Power input	85 – 276 VAC 50Hz / 60Hz
Current drain	315 mA max



Safety Notes

Consider and follow these notes when you are setting up, connecting and using the XMG-51 DMX merger:

- Connect all input and output cables only with appropriate plugs and sockets.
- Set the cables accident-proof. Connected cables mustn't be stressed mechanically too much when connected to this or any other electrical device.
- Keep this device away from sources of electrical interference.
- Only connect accessories certified for this device.
- Never open the device yourself. This should be done by certified SWISSON Technicians. NEVER, UNDER ANY CIRCUMSTANCE SHOULD THIS DEVICE OR ANY OTHER DEVICE BE OPENED WHILE CONNECTED TO A POWER SUPPLY. Don't touch the plug contacts with metal or pointed instruments.
- Clean the XMG-51 only with a soft, damp cloth. Don't use chemicals or other cleaning/ scrubbing agents.
- Protect the device against liquids, dust and wetness.
- Don't use or place this product in direct sunlight.
- Don't use the device in a highly combustible area.

